



**Bipin Nambiar**  
(SBI PO 2018)



**Shiraz Khan**  
(SBI Clerk 2018)



**Kuldeep Yadav**  
(SBI PO 2018)



**Rajat Saxena**  
(IBPS Clerk 2018)



**Anupam Tyagi**  
(IBPS PO 2018)

FRIENDS!  
WE USED **TESTZONE**  
AND CRACKED BANK EXAMS

बैंक परीक्षाओं के लिए निश्चित  
रूप से सर्वश्रेष्ठ मॉक  
टेस्ट सीरीज

IT'S YOUR TURN NOW  
TAKE A **FREE** MOCK TEST



**Smartkeeda**  
The Question Bank

## Blood Relation Questions for IBPS Clerk Pre, RRB Office Asst. Pre and SBI Clerk Pre Exams.

**Directions :** Study the following information carefully and answer the questions given beside.

**1.** B is father of Q. B has only two children. Q is the brother of R. R is the daughter of P. A is the granddaughter of P. S is the father of A. How is S related to Q?

- A. Son                      B. Son-in-law                      C. Brother                      D. Brother-in-law                      E. None of these

**Directions :** Study the following information carefully and answer the questions given beside. [Set of 2 Questions]

Abhishek is son of Amitabh's father's sister. Prakash is son of Teji who is mother of Vikash and grandmother of Amitabh. Harivansh is father of Neela and grandfather of Abhishek. Teji is wife of Harivansh.

**2.** How is Abhishek related to Teji?

- A. Grandson                      B. Son                      C. Data Inadequate                      D. Brother                      E. None of these

**3.** How is Vikas's wife related to Neela?

- A. Sister                      B. Niece                      C. Niece                      D. Data Inadequate                      E. None of these

**Directions :** Study the following information carefully and answer the questions given beside. [Set of 2 Questions]

B and C are siblings. M has two children and he is son of E, who is father-in-law of H. H has only one son. C is not granddaughter of E.

**4.** How is B related to E?

- A. Granddaughter                      B. Son                      C. Daughter                      D. Can't be determined                      E. None of these

**5.** How is H related to M?

- A. Husband                      B. Wife                      C. Daughter                      D. Son                      E. None of these



**Directions : Study the following information carefully and answer the questions given beside. (Set of 3 Questions)**

In a family of six persons – Anu, Ayushi, Sohan, Ajay, Anupam and Anuj – there are three males and three females. There are two married couples and two persons are unmarried. Each one of them reads different newspapers, viz. Doctor, Engineer, Lawyer, Teacher, Writer and Architect.

Anupam, who works as Engineer, is mother-in-law of Anu, who is wife of Sohan. Ajay is the father of Anuj and he does not read Doctor or Architect. Ayushi works as Writer and is the sister of Anuj, who works as Lawyer. Sohan does not works as Architect.

**6. Who among the following works as doctor?**

- A. Sohan                      B. Ajay                      C. Anu                      D. Data inadequate      E. None of these

**7. How is Anuj related to Anupam?**

- A. Daughter                      B. Brother                      C. Son                      D. Data inadequate      E. None of these

**8. How many sons does Anupam have?**

- A. Four                      B. Three                      C. Two                      D. One                      E. None of these

**9. Daksha has two sons Badal and Fezan. Badal is married to Utkal. Utkal is mother of Shruti. Lakshit is daughter of Daksha. Yadu is mother in law of Utkal. How is Shruti related to Daksha?**

- A. Son                      B. Granddaughter      C. Grandson                      D. Either grandson or granddaughter  
E. None of these

**10. Rohit has two sons namely Bittu and Kittu. Bittu is husband of Gillu. Lata is the mother in law of Gillu and Sittu. Sittu is mother of Mitthu. How is Mitthu related to Rohit?**

- A. Granddaughter      B. Grandson                      C. Daughter in law      D. Can't be determined  
E. None of these



**Directions : Study the following information carefully and answer the questions given beside. (Set of 3 Questions)**

The Hansraj family consists of eight members P, Q, R, S, T, U, V and W. Among these eight members, there are three generations in which there are four male and four female members. Among all, each off-spring has both the parents alive.

The husband of R's sister has two daughters. The husband of T's daughter is married to V. V has only one sibling. U's father-in-law has two granddaughters. W's brother has only one nephew and W is not V's mother. R is unmarried and Q has only one niece.

**11. Which of the following is the grandmother of S?**

- A. W                      B. T                      C. V                      D. U                      E. None of these

**12. Who among the following is the Uncle of U's spouse?**

- A. W                      B. T                      C. R                      D. Q                      E. None of these

**13. Which of the following is a combination of the couple discussed in the information part?**

- A. Q and W              B. T and R              C. W and T              D. P and S              E. None of these

**Directions : Study the following information carefully and answer the questions given beside. (Set of 2 Questions)**

There are seven family members in a family in which four are males and three are females and two married couple in that family.

S is the brother-in-law of T and paternal uncle of P.

R is the father of V and son of M.

V is sister of P and Q is grandfather of V.

**14. Who is the mother of V?**

- A. R                      B. M                      C. S                      D. T                      E. None of these

**15. How is Q related with T?**

- A. Father                      B. Grandfather                      C. Father-in-law                      D. Son                      E. None of these



**Directions : Study the following information carefully and answer the questions given beside. (Set of 3 Questions)**

- 'B + A' means 'A is son of B'
- 'B x A' means 'A is father of B'
- 'A % B' means 'A is son-in-law of B'
- 'B - A' means 'A is wife of B'
- 'A \* B' means 'B is brother of A'
- 'A # B' means 'B is the only sister of A'

**16. Which two symbols will come in place of question marks in the following equation to show that E is wife of X?**

$$X \% P - C ? D ? E$$

- A. x and +                      B. + and –                      C. + and #                      D. Either A or C                      E. None of these

**17. Which symbol will come in place of question mark in the following equation to show that V is daughter-in-law of L?**

$$V + Z x T ? L$$

- A. +                      B. %                      C. #                      D. x                      E. None of these

**18. Which symbol will come in place of question marks in the following equation to show that L is paternal aunt of P?**

$$P x Q x R + S ? L$$

- A. #                      B. x                      C. –                      D. Either A or C                      E. None of these

**Directions : Study the following information carefully and answer the questions given beside. (Set of 2 Questions)**

There are two couples in a family. K has two children. M is wife of O, who is brother of B. F is daughter of K. U is sister of S, who is son of O. T is son of B, who is a male.

**19. How is M is related to K?**

- A. Sister                      B. Sister in law                      C. Brother                      D. Can't be determined  
E. None of these

**20. How is U is related to T?**

- A. Mother                      B. Brother                      C. Sister                      D. Cousin                      E. None of these

**Directions : Study the following information carefully and answer the questions given beside. (Set of 3 Questions)**

There are eight family members Anupam, Bhuika, Mohini, Hitesh, Vishnu, Ruchika, Sanshlesh and Pritam. Vishnu is uncle of Sanshlesh, who is daughter of Pritam. There are two married couples in the family and two grandchildren in the family. Mohini has one daughter and one son. Anupam is granddaughter of Ruchika and sister of Bhumika. Ruchika is sister in law of Vishnu. Mohini is not a male. Sanshlesh has only one brother.

**21. How Pritam is related to Hitesh?**

- A. Mother                      B. Father                      C. Brother                      D. Can't be determined                      E. None of these

**22. How Bhumika is related to Sanshlesh?**

- A. Son                      B. Daughter                      C. Niece                      D. Nephew                      E. None of these

**23. Who among the following is mother of Anupam?**

- A. Sanshlesh                      B. Hitesh                      C. Mohini                      D. Ruchika                      E. None of these

**Directions: Read the following information carefully and answer the questions given beside:**

I. K is brother of F. U is wife of nephew of L who is wife of K.

II. P is brother of M. W is son of M. U is mother of W.

III. C is wife of F. F is father of M. F has two children.

**24. How is L is related to M?**

- A. Aunt                      B. Mother                      C. Father                      D. Uncle                      E. None of these

**25. There are six members – P, Q, R, S, T and U are in a family. P and Q are a married couple. P is one of the male members. S is the only son of R who is brother of P. T is the sister of S. Q is the daughter-in-law of U, whose husband has passed away. How many female members are there in the family?**

- A. Can't be determined                      B. Only one                      C. Two                      D. Three                      E. None of these

**Directions : Study the following information carefully and answer the questions given beside. (Set of 3 Questions)**

In a combined family Mayank and Suresh are brothers. Both have one – one son and daughter each. Further information of their family is given below:

Amar is brother-in-law of Munesh and husband of Amal's mother.

Munesh is unmarried son of Mayank.

Vaishnavi's father, Vikram is son of Seema who is mother-in-law of Sakshi.

Mainak's grandmother, Kavita is mother-in-law of Amar.

Madhuri and Munesh are children of Mayank and Vikram and Tanuja are their cousins.

Sakshi has two daughters and Madhuri have two sons. Juhi and Vaishnavi are siblings.

**26. How does Vaishnavi relate to Suresh?**

- A. Daughter-in-law    B. Niece    C. Wife    D. Granddaughter    E. None of these

**27. Who among the following is the father of Vaishnavi?**

- A. Vikram    B. Amal    C. Amar    D. Mainak    E. None of these

**28. How is Mainak related to Seema?**

- A. Son of brother in law    B. Cousin of sister in law    C. Grandson's cousin  
D. Grandson of brother in law    E. None of these

**29. Introducing a boy, a girl said, " He is the only son of my mother's mother". How is the girl related to that boy?**

- A. Aunt    B. Niece    C. Sister    D. Mother    E. None of these

**30. Pointing to Rajat in the photograph, Ravi said, "His mother has only one grandchild whose mother is my sister."How is Ravi related to Rajat ?**

- A. Brother    B. Brother-in-law    C. Father-in-law    D. Data inadequate    E. None of these



**Directions : Study the following information carefully and answer the questions given beside. (Set of 3 Questions)**

If A + B means A is the father of B

If A × B means A is the sister of B

If A \$ B means A is the wife of B

If A % B means A is the mother of B

If A ÷ B means A is the son of B

**31. Which among the given expressions indicates that M is the daughter of D?**

A.  $L \% R \$ D + T \times M$

B.  $L + R \$ D + M \times T$

C.  $L \% R \% D + T \div M$

D.  $D + L \$ R + M \times T$

E.  $L \$ D \div R \% M \div T$

**32. Which among the following expression is true if Y is the son of X is definitely false?**

A.  $W \% L \times T \times Y \div X$

B.  $W + L \times T \times Y \div X$

C.  $X + L \times T \times Y \div W$

D.  $W \$ X + L + Y + T$

E.  $W \% X + T \times Y \div L$

**33. What should come in place of question mark (?), to establish that T is the sister-in-law of Q in the expression?**

$R \% T \times P ? Q + V$

A. ÷

B. %

C. ×

D. \$

E. Either \$ or ×

**Directions : Study the following information carefully and answer the questions given beside. (Set of 2 Questions)**

There are two couples – Mr. and Mrs. Iyer and Mr. and Mrs. Khanna. The Iyer's have only one child – Vineet. The Khanna's have only one child, a daughter – Kavita. Further, it is known that exactly one of the following cases is true:

I. Mr. Iyer is Mrs. Khanna's brother.

II. Mr. Khanna is Mrs. Iyer's brother.

III. Mrs. Iyer is Mrs. Khanna's sister.

**34. If Mrs. Khanna is Vineet's aunt, which of the following cases could be the correct one?**

A. Only I

B. Only II

C. Only III

D. Either I or II

E. Either I or III

[www.smartkeeda.com](http://www.smartkeeda.com) | [testzone.smartkeeda.com](http://testzone.smartkeeda.com)

SBI | RBI | IBPS | RRB | SSC | NIACL | EPFO | UGC NET | LIC | Railways | CLAT | RJS



Join us



**35. Which of the following statements is definitely true about the common grandfather of Vineet and Kavita, if one disregards case II?**

- A. He is the father of Mr. Iyer.                      B. He is the father-in-law of Mr. Khanna.  
C. He is the father-in-law of Mr. Iyer.            D. He is the father of Mr. Khanna.  
E. None of these

**Directions : Read the following information carefully and answer the questions. [Set of 3 Questions]**

Cheenu has a family of eight members. Bablu is the eldest male member of the family. Haryali is the daughter-in-law of Neelu and sister-in-law of Sonu and Anku. Apart from Cheenu and Bablu, only Sonu is a male member of the family. Anku is the aunt of Cheenu's two daughters Saba and Daya.

**36. How is Daya related to Sonu?**

- A. Grandmother      B. Niece                      C. Mother                      D. Aunt                      E. None of these

**37. Find the relation between Haryali and Saba?**

- A. Mother – daughter      B. Father – son                      C. Sisters                      D. Granddaughter – grandmother  
E. None of these

**38. Who is the husband of Haryali?**

- A. Bablu                      B. Sonu                      C. Cheenu                      D. Can't be determined                      E. None of these

**Directions : Read the following information carefully and answer the questions. [Set of 3 Questions]**

Q is father of A and B. X is mother of K, N is son of A. N is the only brother of K. X is daughter-in-law of P. P has only one daughter and one son.

**39. Which of the following needs to be true to establish that K is daughter of X?**

- A. B is unmarried                      B. X has only one son                      C. N is grandson of Q  
D. No extra information is required                      E. None of these

**40. How is K related to Q?**

- A. Daughter                      B. Grandson                      C. Granddaughter                      D. Either B or C                      E. None of these

**41. How is X related to B?**

- A. Sister                      B. Daughter                      C. Mother                      D. Mother in law                      E. None of these

**Directions : Study the following information carefully and answer the questions [Set of 3 questions]**

Roop is father of Geet and Meet is mother of Roop. Tony is sister of Tanu whose daughter is Soni. Kanu, the husband of Meet is the grandfather of Soni. Moni is father of Tony and brother of Preet. Kanu has only two children, both of opposite gender.

**42. Relationship between which of the following two persons cannot be determined?**

- A. Soni – Tony      B. Roop – Tanu      C. Geet – Kanu      D. Moni – Tony      E. None of them

**43. If Sona is the sister in law of Tanu then how is Tony related to Geet?**

- A. Sister      B. Aunt      C. Daughter      D. Mother      E. Can't be determined

**44. How is Preet related to Tanu?**

- A. Aunt      B. Mother      C. Sister      D. Uncle      E. Can't be determined

**45. Pointing to a photograph, a woman said, "His father is the only son of my daughter's grandmother's husband." How is the person in the photograph related to the woman?**

- A. Father      B. Son      C. Husband      D. Brother      E. None of these

**Directions: Read the given information carefully and answer the questions given beside:**

In a family of some persons Sushant says that Manu is the daughter of my sister Rhea, who is the only daughter of Tahir. Arun is the child of Tahir and Ileana, who is the grandmother of Kiara. Roma is the mother of Trisha, who is the only sister of Kiara. Arun is unmarried.

**46. How is Arun related to Kiara?**

- A. Maternal Uncle      B. Maternal Aunt      C. Paternal Uncle      D. Paternal Aunt      E. Can't be determined

**47. How is Kiara related to Tahir?**

- A. Daughter-in-law      B. Grand Daughter      C. Grand Son      D. Either option B or C      E. None of these

**48. If Micky is spouse of Rhea, how is Roma related to Micky?**

- A. Sister      B. Brother-in-law      C. Wife of Brother-in-law      D. Cousin      E. None of these

**49. Which of the following statements is possibly false?**

- A. Rhea is a cousin of Arun.      B. Tahir is paternal grandfather of Manu.  
C. Kiara is a nephew of Arun.      D. Ileana is father-in-law of Roma.      E. All are possibly false.

**50. What will Akram, son of Tahir's brother Kiku, call Sushant?**

A. Brother

B. Sister

C. Uncle

D. Nephew

E. None of these



[www.smartkeeda.com](http://www.smartkeeda.com) | [testzone.smartkeeda.com](http://testzone.smartkeeda.com)

SBI | RBI | IBPS | RRB | SSC | NIACL | EPFO | UGC NET | LIC | Railways | CLAT | RJS



**CORRECT ANSWERS:**

<b>1</b>	<b>2</b>	<b>3</b>	<b>4</b>	<b>5</b>	<b>6</b>	<b>7</b>	<b>8</b>	<b>9</b>	<b>10</b>
D	A	C	A	B	A	C	C	D	D
<b>11</b>	<b>12</b>	<b>13</b>	<b>14</b>	<b>15</b>	<b>16</b>	<b>17</b>	<b>18</b>	<b>19</b>	<b>20</b>
B	D	C	D	C	C	D	D	B	D
<b>21</b>	<b>22</b>	<b>23</b>	<b>24</b>	<b>25</b>	<b>26</b>	<b>27</b>	<b>28</b>	<b>29</b>	<b>30</b>
B	D	C	A	D	D	A	D	B	D
<b>31</b>	<b>32</b>	<b>33</b>	<b>34</b>	<b>35</b>	<b>36</b>	<b>37</b>	<b>38</b>	<b>39</b>	<b>40</b>
B	D	D	E	B	B	A	C	B	D
<b>41</b>	<b>42</b>	<b>43</b>	<b>44</b>	<b>45</b>	<b>46</b>	<b>47</b>	<b>48</b>	<b>49</b>	<b>50</b>
E	C	B	E	B	C	D	C	C	E



[www.smartkeeda.com](http://www.smartkeeda.com) | [testzone.smartkeeda.com](http://testzone.smartkeeda.com)

SBI | RBI | IBPS | RRB | SSC | NIACL | EPFO | UGC NET | LIC | Railways | CLAT | RJS



## Explanations :

1.

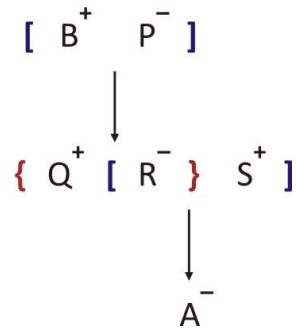

Hence, the option D is correct.

2.

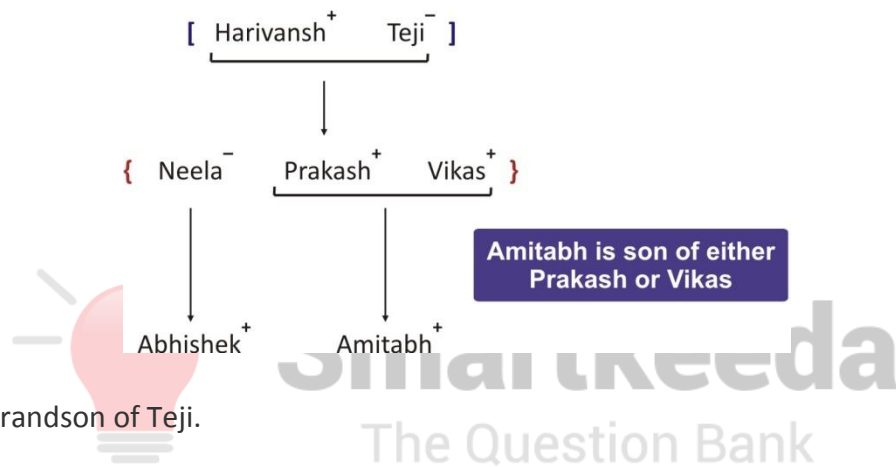

Abhishek is grandson of Teji.

Hence, the option A is correct.

3.

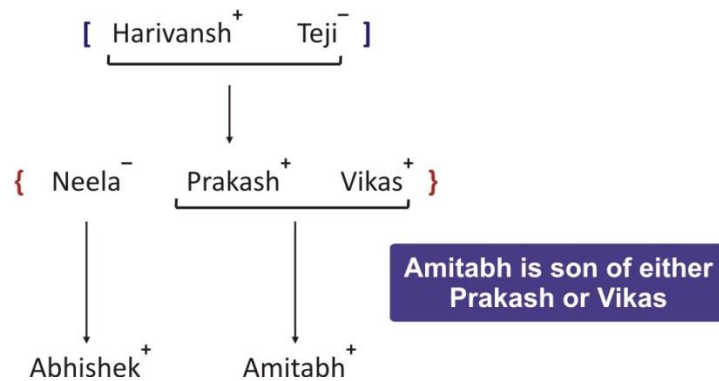

Neela is sister of Vikas, Therefore, Vikas's wife is sister-in-law of Neela.

Hence, the option C is correct.

4.

Family Tree

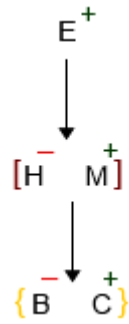

B is granddaughter of E.

Hence, the option A is correct.

5.

Family Tree

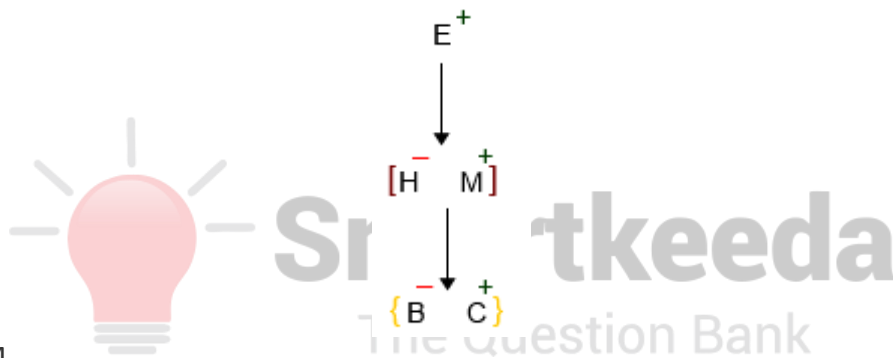

H is wife of M.

Hence, the option B is correct.

6.

We can clearly observe from the figure that Sohan works as Doctor.

Hence, option A is correct.

Family Tree

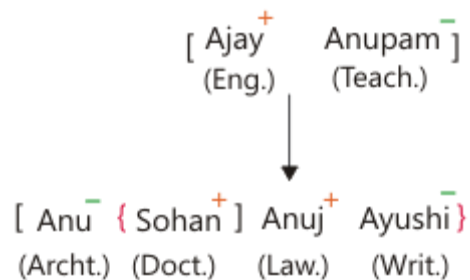

7. We can clearly observe from the figure that Anuj is the son of Anupam.

Hence, option C is correct.

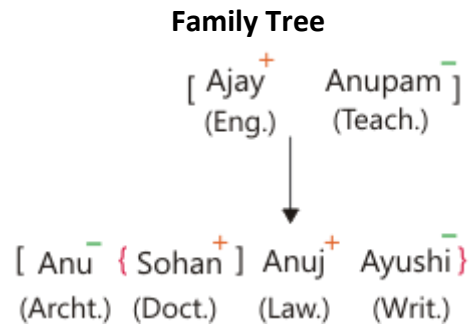

8. We can clearly observe from the figure that Anupam has two sons.

Hence, option C is correct.

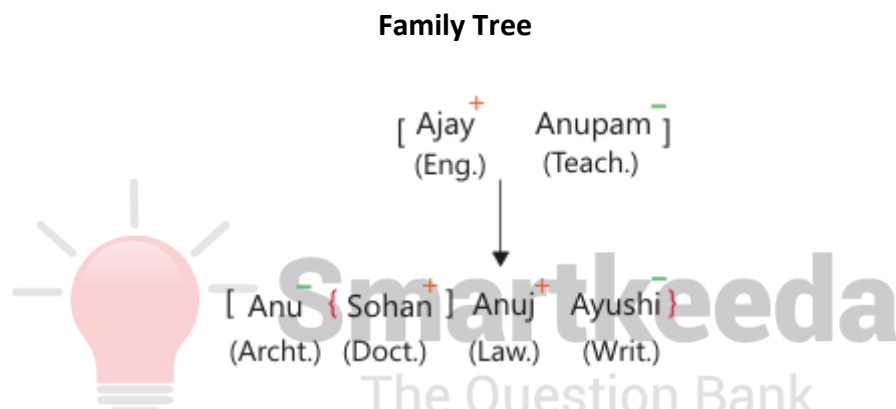

9. Here, we don't have gender information about Shruti. So, Shruti can be either granddaughter or grandson of Daksha.

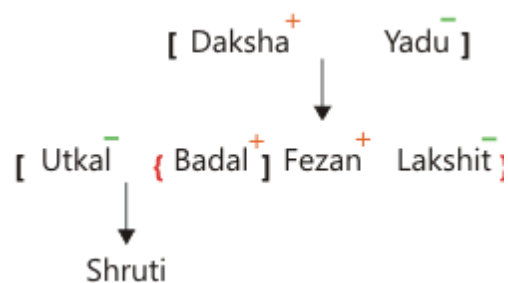

Hence, the correct answer is option D.

10. Following the blood relation image, we cannot define Mitthu's relation with Rohit, as we don't have gender information about Mitthu. It can be either granddaughter or grandson of Rohit.

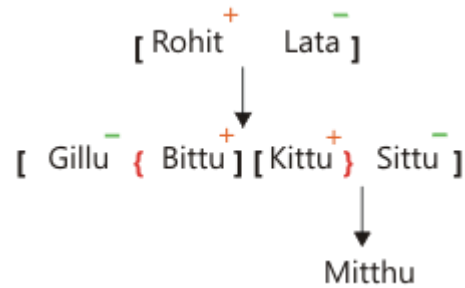

Hence, the correct answer is option D.

### Common Explanation: (Q11 to Q13)

References:

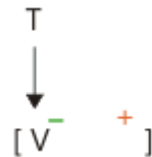

The husband of T's daughter is married to V.

References:

U's father-in-law has two granddaughters.

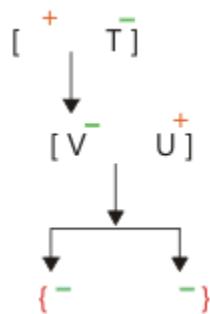

References:

The husband of R's sister has two daughters.

V has only one sibling.

W's brother has only one nephew and W is not V's mother. R is unmarried and Q has only one niece.



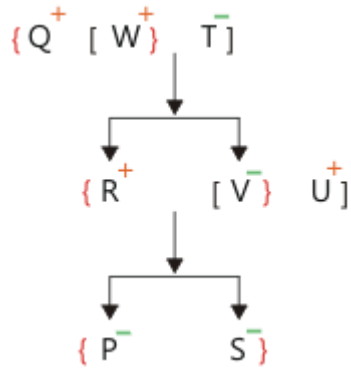

And the chart gets done.

11. Following the final figure, we can deduce that it's T who is the grandmother of T.

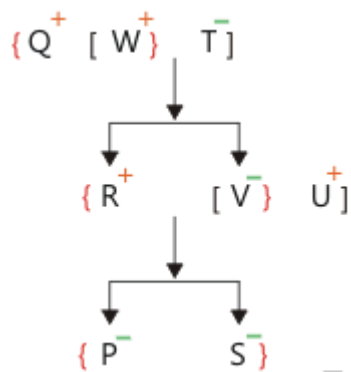

Option B is hence the correct answer.

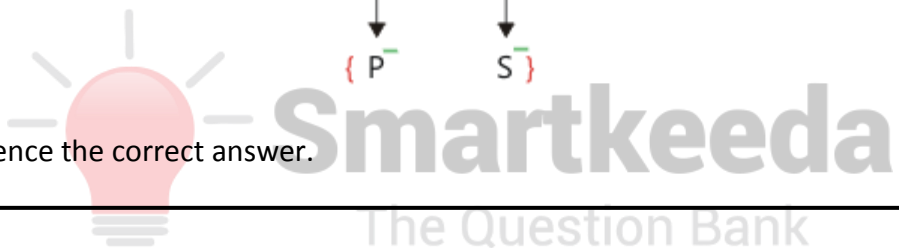

12. Following the final blood relation tree, we can deduce that it's Q who is the Uncle of U's spouse who is V.

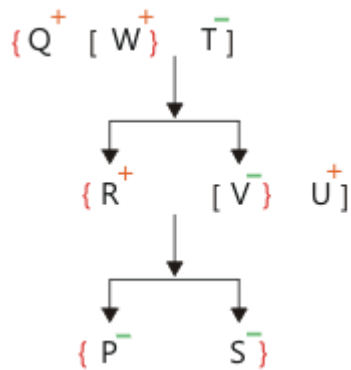

Option D is hence the correct answer.

13. We can clearly observe from the figure that there are two couples - W and T and V and U in the family tree.

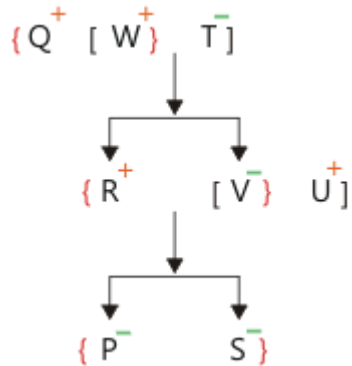

Option C is hence the correct answer.

14. Following the final family chart, we can say that T is mother of V.

Hence, the correct answer is option D.

Family Tree

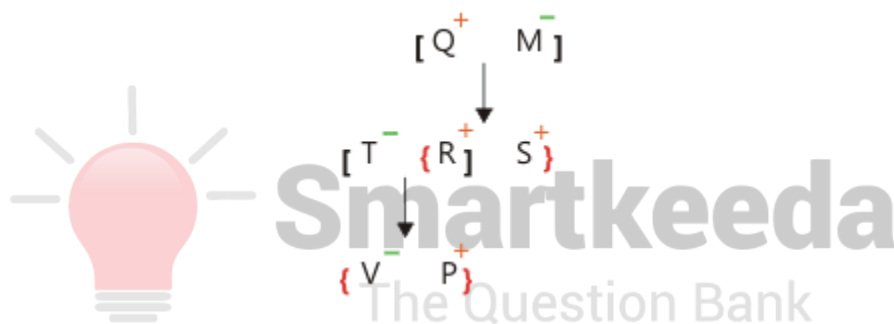

15. Following the family chart we can say that Q is Father in law of T.

Hence, the correct answer is option C.

Family Tree



16. This question can be solved using the elimination technique.

Out of the given options, only option C fits the blanks appropriately as we can observe from the Blood Relation tree given below.

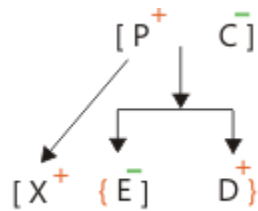

Option C is hence the correct answer.

17. This question can be solved using the elimination technique.

Out of the given options, only option D fits the blanks appropriately as we can observe from the Blood Relation tree given below.



Option D is hence the correct answer.

18. This question can be solved using the elimination technique.

Out of the given options, we can define the given relationship using either option A or option C. And we can observe this from the following diagrams.

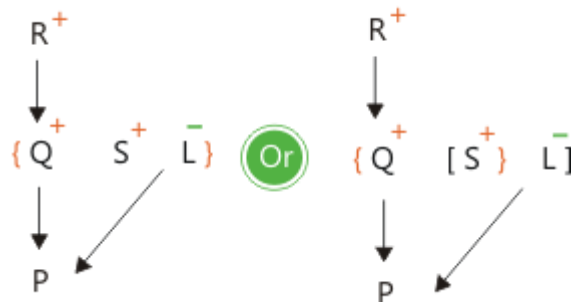

Option D is hence the correct answer.

19. Following the final family tree we can say that M is sister in law of K.

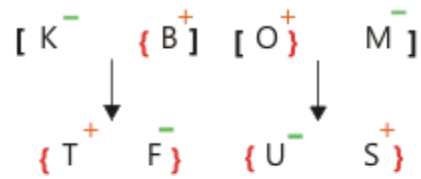

Hence, the correct answer is option B.

20. Following the final seating arrangement we can say that T is cousin of S.

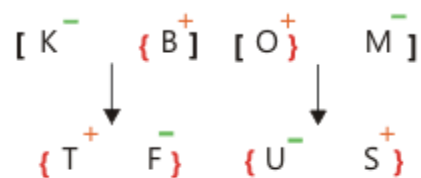

Hence, the correct answer is option D.

21. Observing the final chart, we can say that Pritam is father of Hitesh.

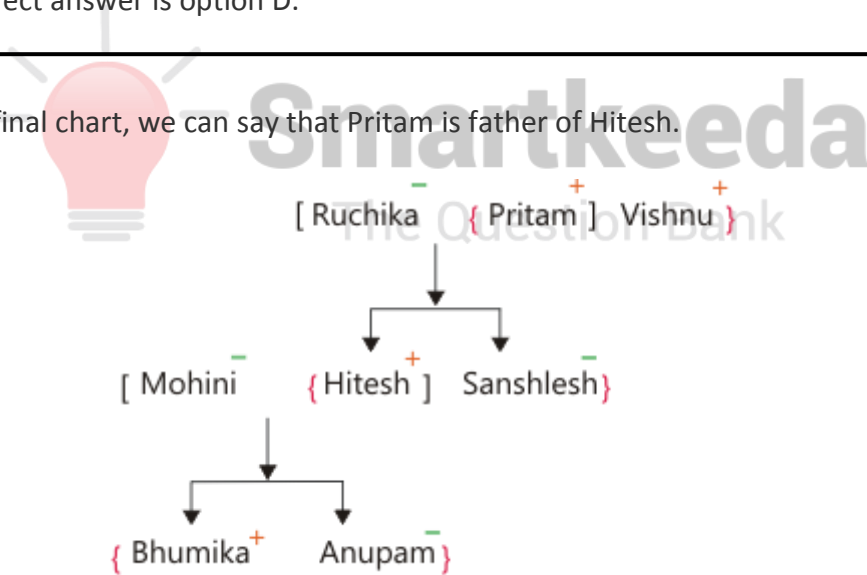

Hence, the correct answer is option B.

22. Observing the final chart, we can say that Bhumika is nephew of Sanshlesh.

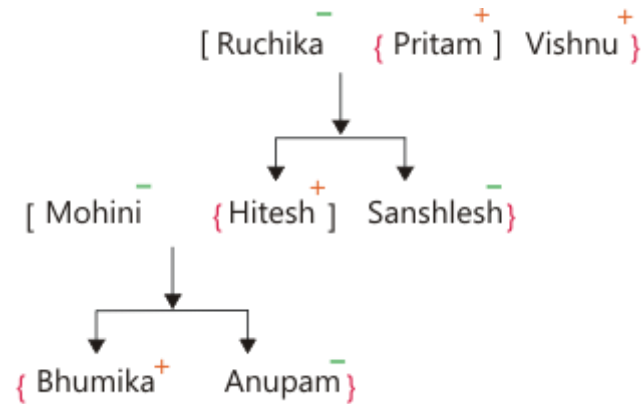

Hence, the correct answer is option D.

23. Observing the final chart, we can say that Mohini is mother of Anupam.

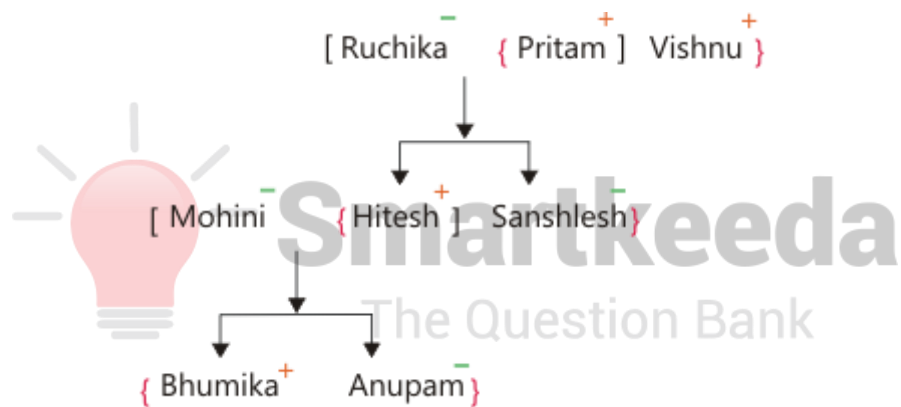

Hence, the correct answer is option C.

24. Following the final blood relation image, we can say that L is aunt of M.

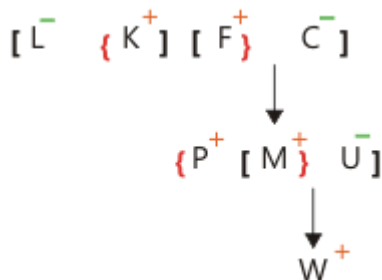

Hence, the correct answer is option A.

25. Following the family tree, we can see that there are three female members (U, Q and T) in the family.

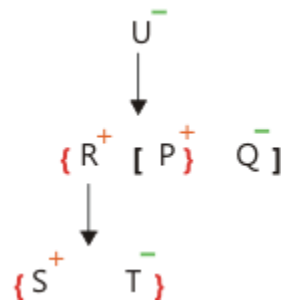

Option D is hence the correct answer.

### Common explanation : (Q26 to Q28)

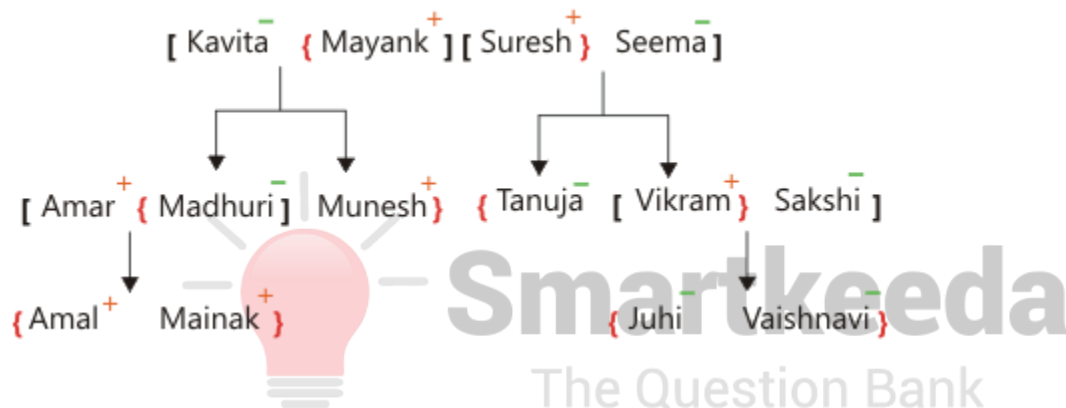

26. Following the final family tree, Vaishnavi is granddaughter of Suresh.

Option D is hence the correct answer.

27. Following the final family tree, it's evident that Vikram is father of Vaishnavi.

Option A is hence the correct answer.

28. Following the final family tree, Mainak is grandson of Mayank who is brother in law of Seema.

Clearly, Mainak is grandson of brother in law.

Option D is hence the correct answer.

29.

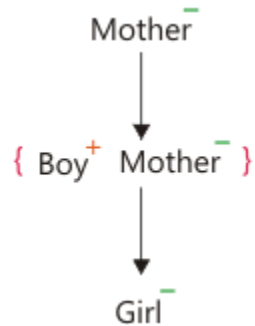

We can clearly observe from the figure above that girl is the niece of the boy.

Hence, option B is correct.

30.

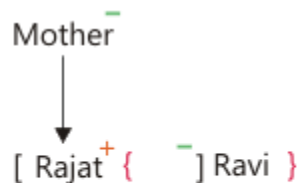

We can clearly observe from the figure that gender of Ravi is not known.

Hence Option D is correct.

31. By just reading the relation coding we get that it's not clearly given what would be the gender of last persons in the expressions.

So, we directly eliminate the option (A) and (C).

Again check for option (B) we get:

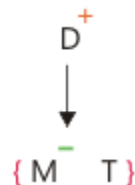

Now it is clear from the family tree that M is the daughter of D.

Hence, option B is correct.

32. Making the family tree by given expression, we get that option (D) is the only expression which through we find that Y is the son of X is definitely false.



Hence, option (D) is false.

33. To find that T is the sister-in-law of Q, we have to put \$ sign.

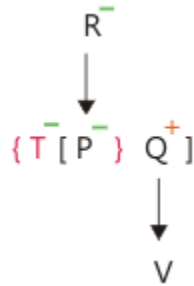

Hence, option D is correct.

34. Either I or III is the correct case.

Option E, is hence the correct answer.

If Mrs. Khanna is Vineet's aunt, this means that Mrs. Khanna must be the sister of either Mr. or Mrs. Iyer.

Clearly, either case I or case III could be the correct one.

35. He is the father-in-law of Mr. Khanna.  
Option B, is hence the correct answer.

The common grandfather of Vineet and Kavita must be the father of those of their parents who are siblings.

Thus, in case I, the common grandfather is the father of Mr. Iyer and Mrs. Khanna.

In case III, he is the father of Mrs. Iyer and Mrs. Khanna.

In both cases, he is the father of Mrs. Khanna, i.e. the father-in-law of Mr. Khanna.



### Common explanation: (Q. 36 to 38)

**Reference:**

Bablu is the eldest male member of the family.

**Inference:**

Bablu<sup>+</sup>

**Reference:**

Haryali is daughter-in-law of Neelu and sister-in-law of Sonu and Anku.

**Inference:**

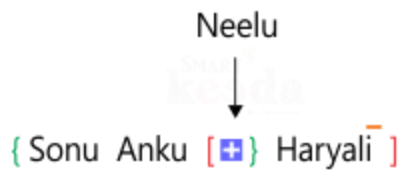

**Reference:**

Anku is the aunt of Cheenu's two daughters Saba and Daya.

**Inference:**

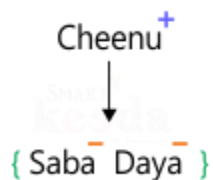

**Reference:**

Apart from Cheenu and Bablu, only Sonu is a male member of the family.

**Inference:**

Merging above given images:

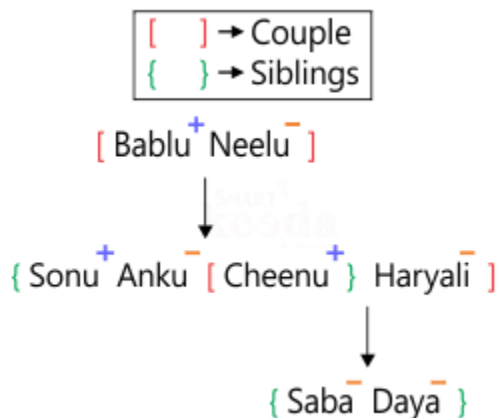

**36.** Following the common explanation, we get

Daya is related to Sonu as his Niece.

Option B, is hence the correct answer

**37.** Following the common explanation, we get

Haryali and Saba is having mother – daughter relationship.

Option A, is hence the correct answer.

**38.** Following the common explanation, we get

Cheenu is Haryali's husband.

Option C, is hence the correct answer.

**Common explanation: [Q. 39 to 41]**

**Reference:**

Q is father of A and B.

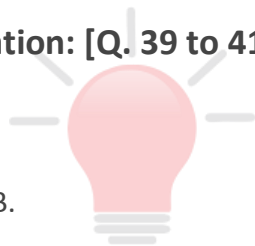

**Smartkeeda**  
The Question Bank

**Inference:**

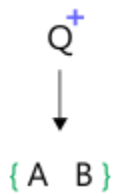

**Reference:**

X is mother of K.

**Inference:**



**Reference:**

N is son of A.  
N is the only brother of K.

**Inference:**



**Reference:**

P has only one daughter and one son.

**Inference:**



**Reference:**

X is daughter-in-law of P.

**Inference:**

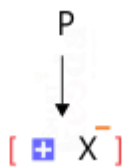

**Combining Image 1, 2 and 3.**

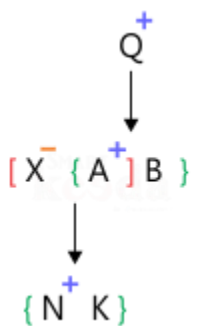

Combining image 4, 5 and 6

[ ] → Couple  
{ } → Siblings

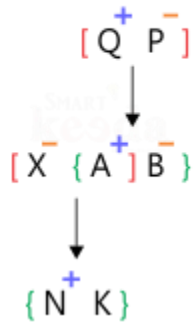

39. Following the common explanation, we get

If it is true that X has only one son then we can say that K is daughter of X.

Option B, is hence the correct answer.

40. Following the common explanation, we get

As K's gender is not defined, K could be either grandson or granddaughter of Q.

Option D, is hence the correct answer.

41. Following the common explanation, we get

X is clearly the sister in law of B.

Option E is hence the correct answer.

**Common Explanation: (Q. 42 to 44)**

**Reference:**

Roop is father of Geet and Meet is mother of Roop.  
Kanu, the husband of Meet is the grandfather of Soni.  
Kanu has only two children, both of opposite gender.

**Inference:**

After using the above hints we can create a following blood chart:

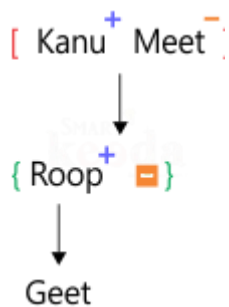

At this point Soni can be the child of either Roop or Roop's sister. So, we will use this information later.

**Reference:**

Tony is sister of Tanu whose daughter is Soni.

Moni is father of Tony and brother of Pret.

**Inference:**

After using the given hints the above blood chart can be redrawn as:

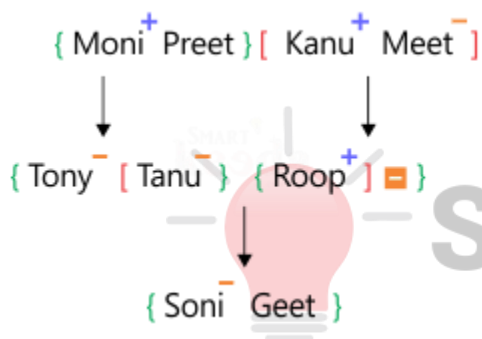

Smartkeeda  
The Question Bank

42. Following the final solution we can say that relationship between Geet – Kanu cannot be determined.  
Hence, the correct answer is option C.

43. Following the final solution we can say that if Sona is the sister in law of Tanu then Tony is the aunt of Geet.  
Hence, the correct answer is option B.

44. Following the final solution we can say that Pret can be either Aunt or Uncle of Tanu.  
Hence, the correct answer is option E.

45. Person's father = Only son of woman's daughter's grandfather's husband's = Woman's husband.  
Hence, option B is correct.

## Common Explanation : (Q46 to Q50)

### Reference:

In a family of some persons Sushant says that Manu is the daughter of my sister Rhea, who is the only daughter of Tahir.

Arun is the child of Tahir and Ileana, who is the grandmother of Kiara.

Arun is unmarried.

### Inference:

From the above hints, following two cases arise.

**Case 1:** When Kiara is the child of Rhea

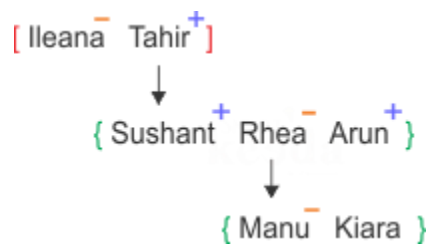

**Case 2:** When Kiara is the child of Sushant

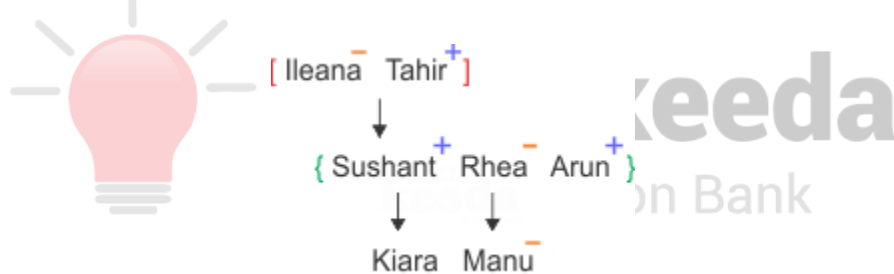

### Reference:

Roma is the mother of Trisha, who is the only sister of Kiara.

### Inference:

As Roma is the mother of Trisha, who is the only sister of Kiara. Thus Kiara and Trisha are siblings.

**So, Rhea can't be mother of Kiara, therefore case 1 fails.**

Thus Kiara is the daughter of Sushant and Roma is his wife.



**46.** From the following image it is clear that Arun is the maternal uncle of Kiara.

Hence option C is correct.

**47.** Following common explanation, we can say that Kiara's gender is not known and therefore Kiara could be either the granddaughter or grandson of Tahir.

Clearly, option D is the correct answer.

**48.** Clearly, Roma is the wife of Sushant who is brother in law of Micky.

Hence, option C is the correct answer.

**49.** If we can observe the statement given, except statement given in option C, all are definitely false.

Only the statement 'Kiara is a nephew of Arun' is possibly false since we are not aware of Kiara's gender.

Option C is the correct answer.

**50.** Son of Tahir's brother will be cousin of Sushant, Arun and Rhea.

Therefore, Akram will call Sushant his 'cousin'.

Option E is hence the correct answer.



**SmartKeeda**

The Question Bank

Presents

# TestZone

India's least priced Test Series platform

JOIN

**ALL BANK EXAMS**

2020-2021 Test Series

@ Just

**₹ 599/-**

**300+ Full Length Tests**

- Brilliant Test Analysis
- Excellent Content
- Unmatched Explanations

**JOIN NOW**